

100975  
200701-01-030102

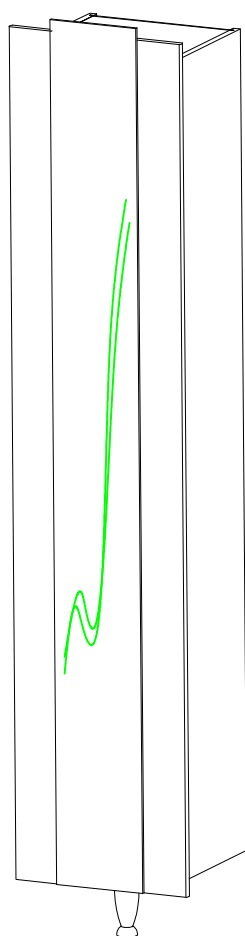



- F** Cette notice est destinée à faciliter le montage du meuble, elle n'est pas contractuelle.
- GB** Fitting instructions are intended to ease fitting. They are not subject to contract.
- D** Unverbindliche Montageanleitung.
- NL** Deze montagenota is gemaakt om de montage van het meubel te vergemakkelijken, zi is niet bindend.
- SP** Esta nota de instrucciones le ayudará a montar el mueble, no es contractual.
- I** Le seguenti istruzioni sono destinate a facilitarvi il montaggio del mobile, e sono indicative.
- P** Esta noticia é destinada a facilitar a montagem do móvel, não é contratual.
- RUS**



- F** Le choix des types de vis et chevilles, ainsi que la méthode de percage pour les fixations murales sont fonction de la nature et de la qualité du mur et, de ce fait, relèvent de la seule responsabilité du poseur.
- GB** Since the type of wall determines the fittings necessary for each unit, bolts and screws have not been supplied but left to the responsibility of the installer.  
Die schrauben, dübel und die bohrungen für die montage müssen der beschaffenheit der jeweiligen wandkonstruktion angepasst werden (mauerwerk, siporex, gisplatten usw), die verantwortung für eine korrekte befestigung trägt der fachmann (monteur, sanitärinstallateur usw).
- D** Die schrauben, dübel und die bohrungen für die montage müssen der beschaffenheit der jeweiligen wandkonstruktion angepasst werden (mauerwerk, siporex, gisplatten usw), die verantwortung für eine korrekte befestigung trägt der fachmann (monteur, sanitärinstallateur usw).
- NL** De keuze van de schoeven en pluggen, evenals de manier van de muur en vallen dus uitsluitend onder de verantwoordelijkheid van diegene die het meubel plaatst.
- SP** La elección del tipo de los torillos y clavijos y el modo de perforar la pared dependen de la naturaleza y de la calidad del muro y por esto dependen de la responsabilidad de la persona quien instala.
- I** La scelta dei tipi di viti e tasselli, oltre che il sistema di foratura per il fissaggio murale sono da scegliere in funzione della struttura e qualità del muro, e per questo. La responsabilità spetta à chi esegue la posa.
- P** A escolha do tipos de parafusos e cavilhas assim que o metodo de furar para colocar as fixacoes murais depende da natureza e da qualidade do muro, e de facto, atribuem a unica responsabilidade ao instalator.
- RUS**

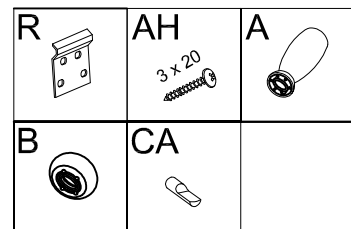
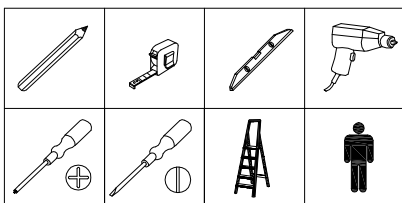
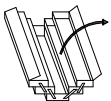
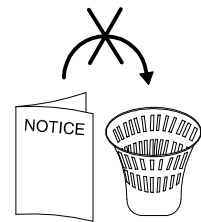
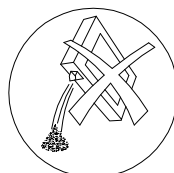
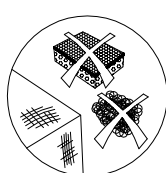
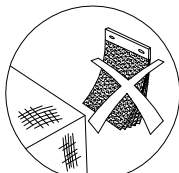
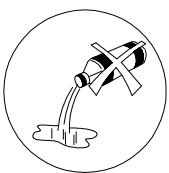
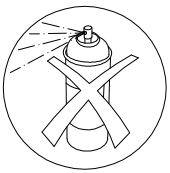

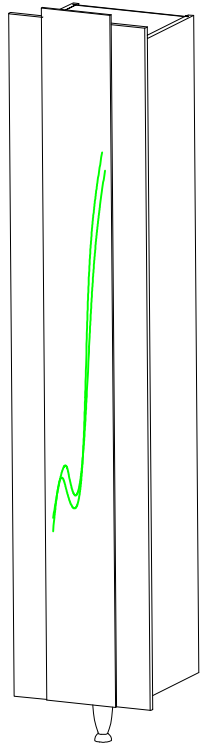

EB934 G

EB934 D

1

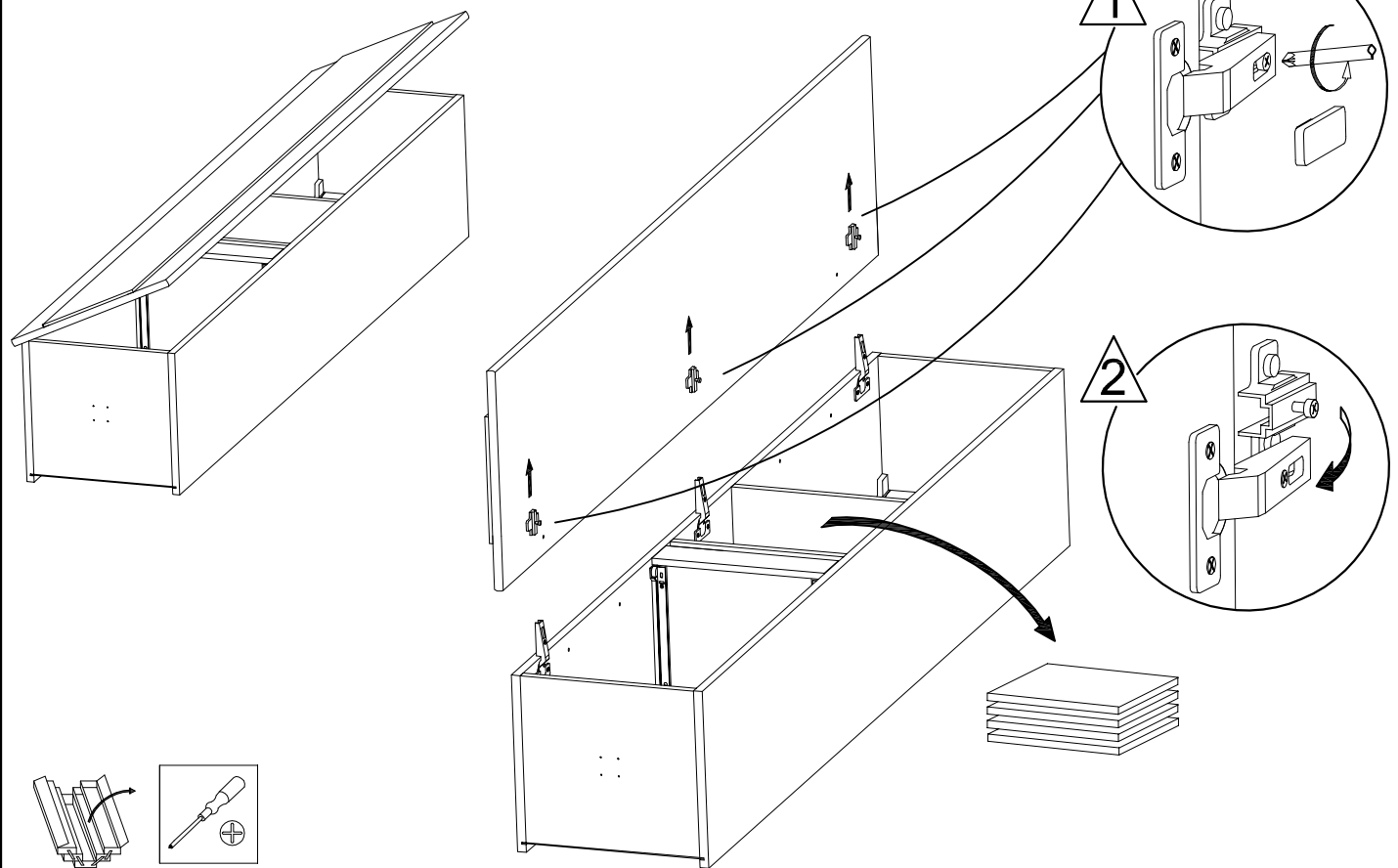

2

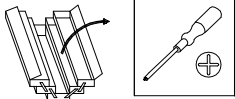
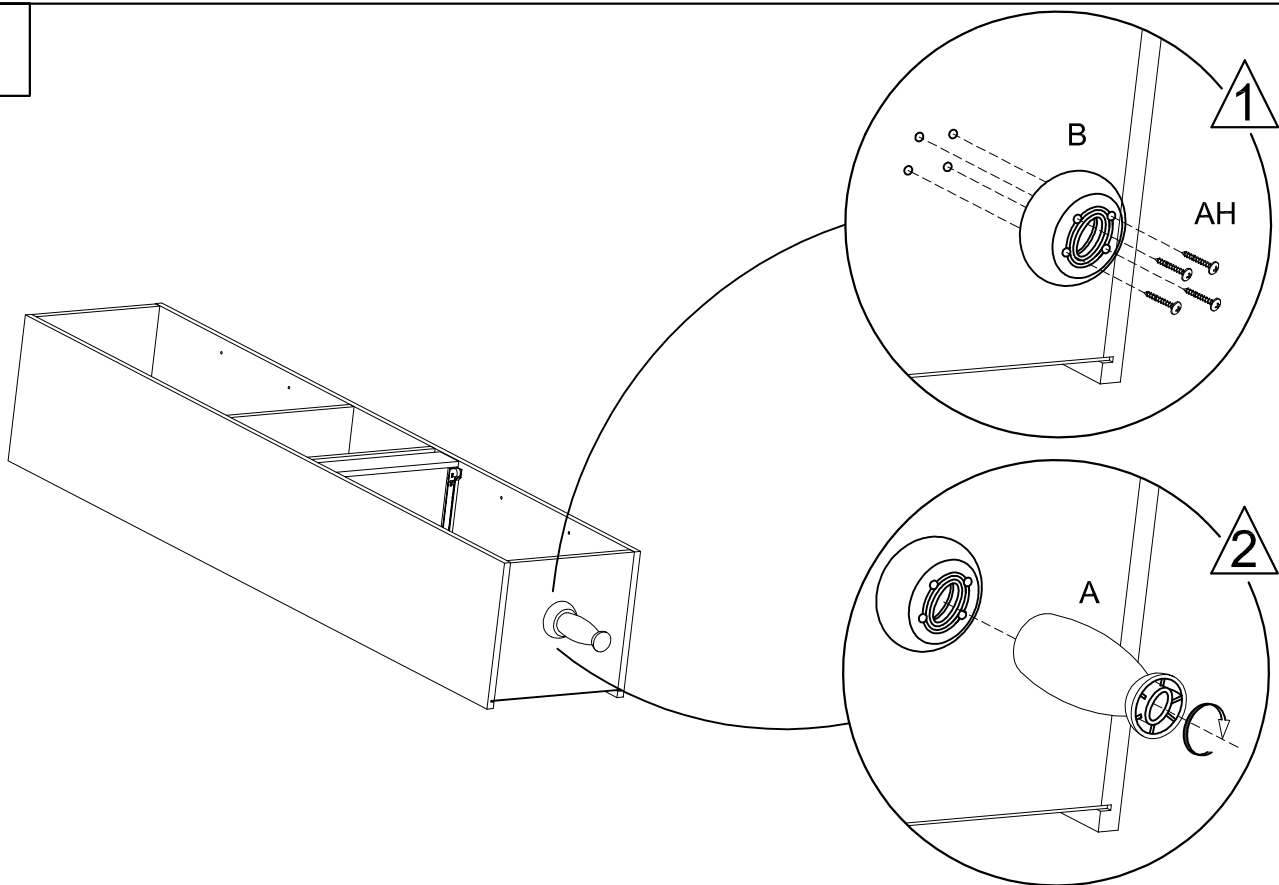

AH 3 x 20 x 4	A x 1	B x 1
---------------------	----------	----------

3

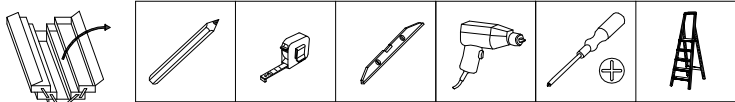
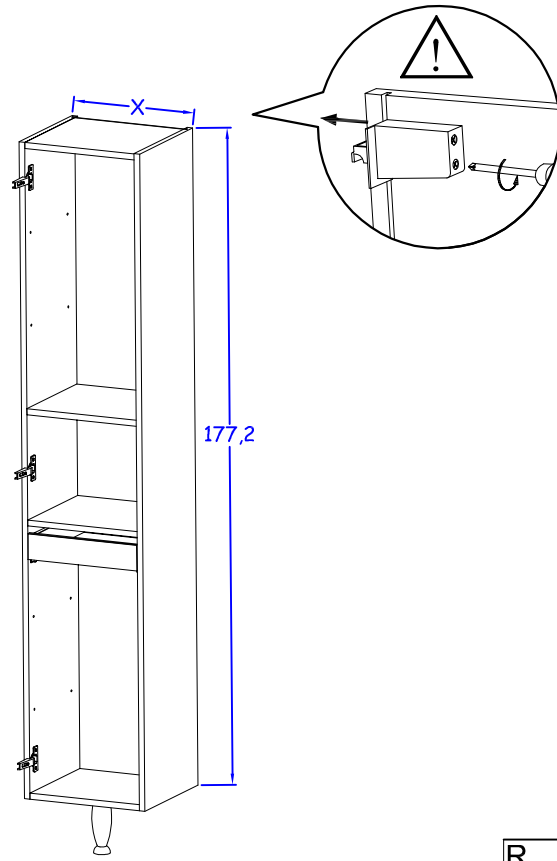
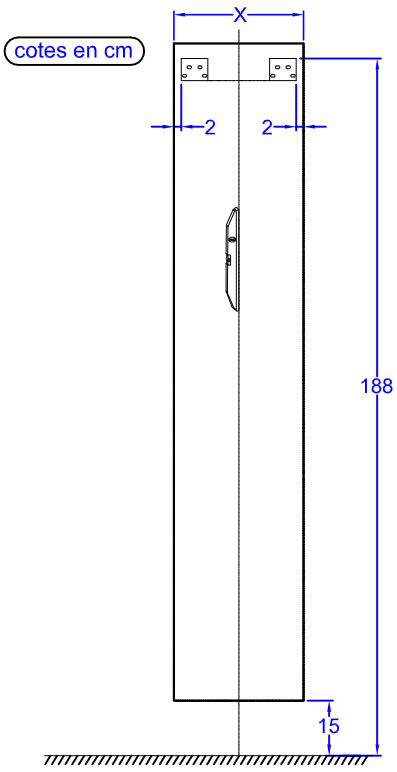

R x 2
----------

4

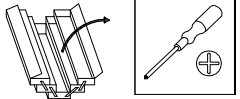
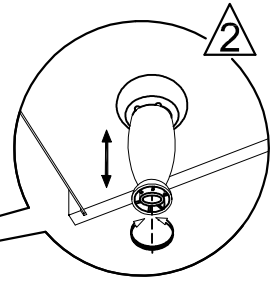
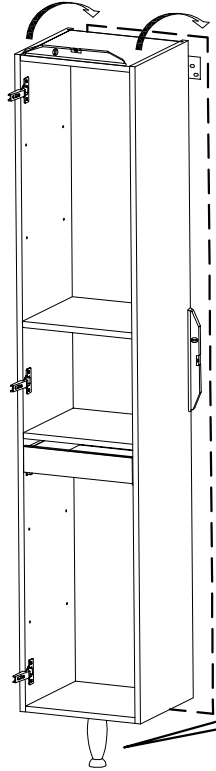
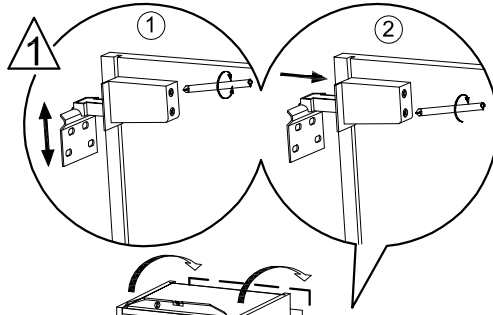

5

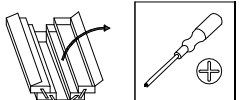
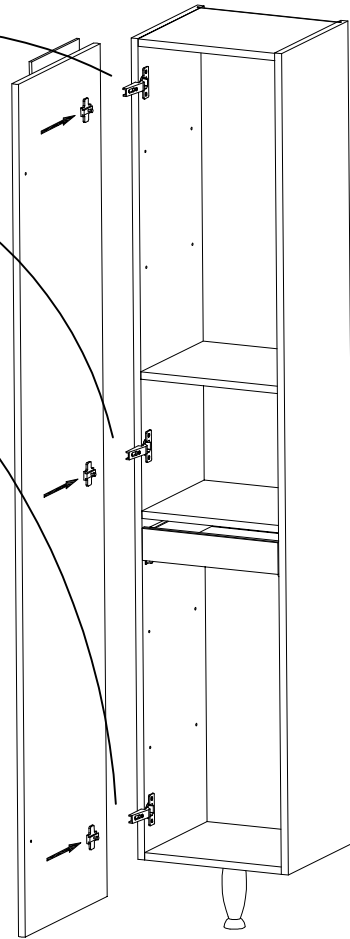
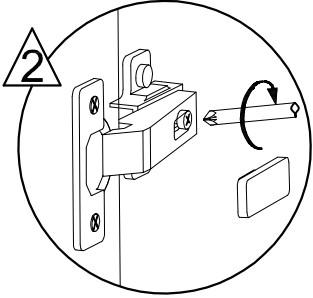
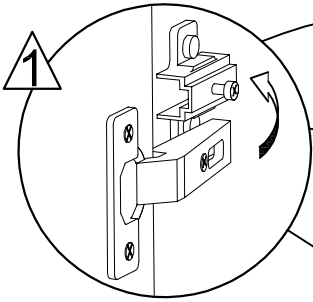

6

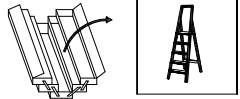
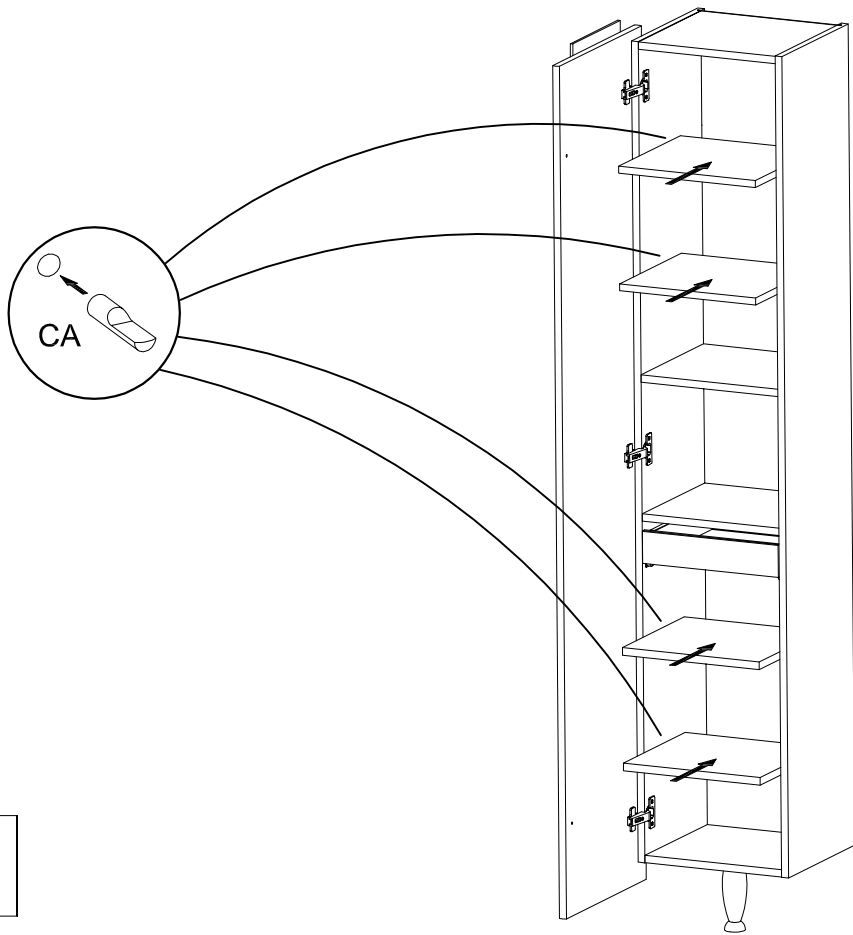

CA  
x 16

7

